

SPEED BY SPECTRE®

The 400mph Company™



Intake Installation Instructions

P/N 9918 (red filter) - P/N 9918B (blue filter)

P/N 9918K (black filter) - P/N 9918W (white filter)

Parts List

- 1 - Intake tube
- 1 - Air filter
- 1 - 4" Offset velocity stack adaptor
- 1 - 4" Flex coupler
- 4 - 4" Hose clamp
- 1 - 6" Hose clamp
- 1 - MAFS Sleeve thick
- 1 - 4" 90° Rubber elbow
- 2- Bolt, hex/flange
- 2- Lock washer
- 3- Allen bolt
- 3- Flat washer
- 3- Locknut
- 1- Allen wrench
- 1 - Heat shield Pc 1
- 1 - Heat shield Pc 2
- 1 - Rubber seal
- 1- 3/8" Breather hose

Tools Required:

- 5/16" or 8mm nut driver
- Ratchet
- 10mm socket
- 13mm socket
- T15 torx
- Phillips screwdriver

Year/Make/Model/Engine

- 2009-2012 Cadillac Escalade 6.2L
- 2009-2012 Chevrolet Avalanche 5.3L, 6.0L
- 2009-2012 Chevrolet Silverado 1500 4.8L, 5.3L, 6.0L, 6.2L
- 2009-2012 Chevrolet Suburban 1500 5.3L, 6.0L
- 2009-2012 Chevrolet Tahoe 4.8L, 5.3L, 6.2L
- 2009-2012 GMC Sierra 1500 4.8L, 5.3L, 6.0L, 6.2L
- 2009-2012 GMC Sierra Denali 6.2L
- 2009-2012 GMC Yukon 4.8L, 5.3L
- 2009-2012 GMC Yukon Denali XL 6.2L
- 2009-2012 GMC Yukon Denali 6.2L
- 2009-2012 GMC Yukon XL 1500 5.3L, 6.0L, 6.2L

This kit comes with a high flow lifetime hpR filter. It is factory pre-oiled and ready to install. For cleaning instructions, visit our website – www.SpeedBySpectre.com

For filter reorders ask at the special order counter of your local parts store or call: 1-909-673-9800

ask for: P/N HPR9891 (red filter)
P/N HPR9891B (blue filter)
P/N HPR9891K (black filter)
P/N HPR9891W (white filter)

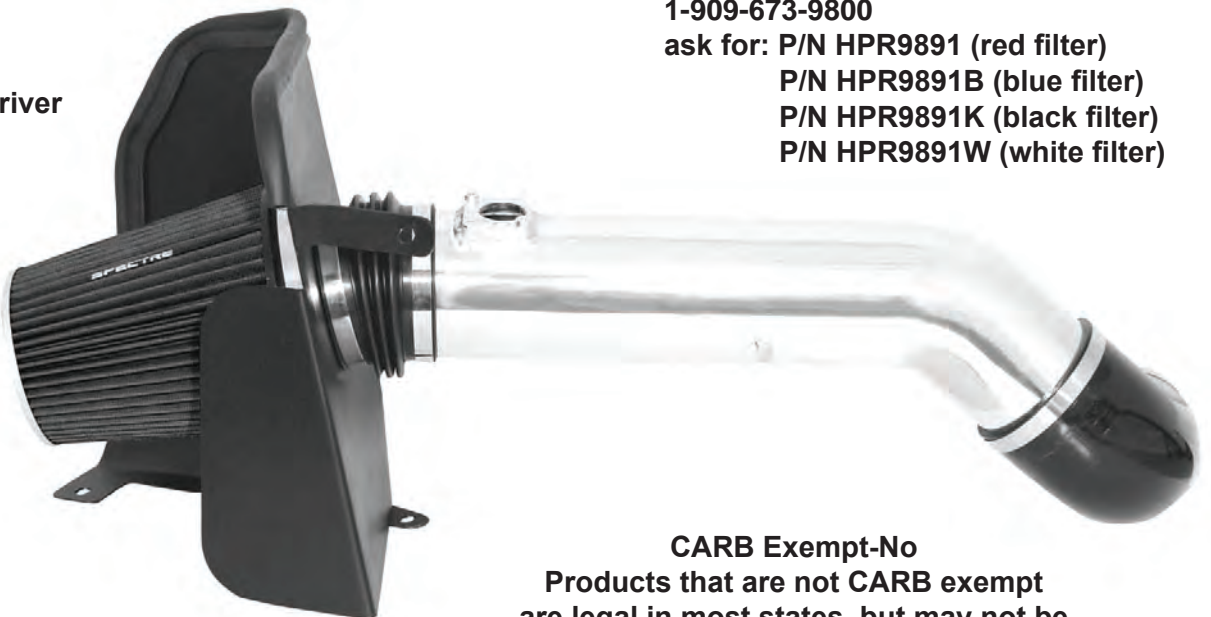

CARB Exempt-No
Products that are not CARB exempt are legal in most states, but may not be used in California or states with similar emissions control laws.



Step 1

Safety first! Before you begin the installation, make sure that the vehicle is in park (or neutral for a manual transmission) with the parking brake set. Disconnect the negative battery terminal and verify that all components that are listed are present. Note: This kit was designed and tested on a stock engine without any custom tuning done to the engine computer. Removing the battery cable may erase the programmed radio stations. The anti-theft code will need to be entered into some radios after the battery cable is connected. The anti-theft code can typically be found in the owner's manual or at your local dealership.

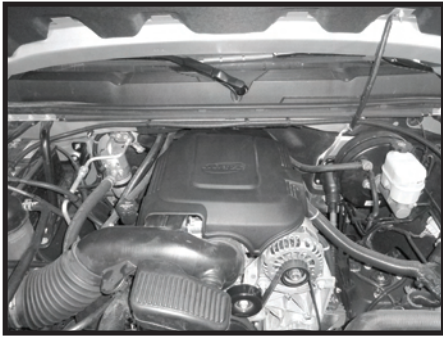

Step 2

Start by removing the engine cover that is attached by small ball and socket joints or fastened with hardware. Lift the cover up and off and it will come off easily. Depending on the year, make, and model the cover may vary.

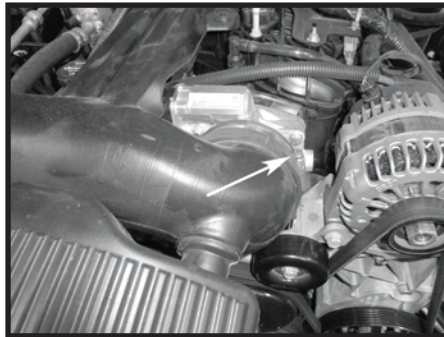

Step 3

Loosen the clamp at the throttle body.

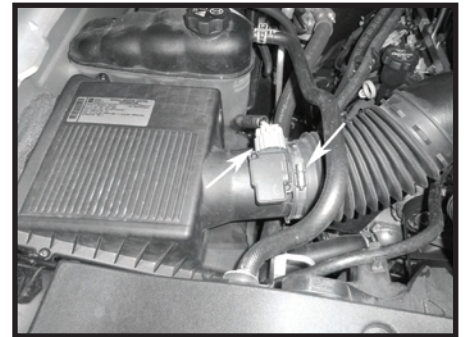

Step 4

Loosen the clamp at the Mass Air Flow Sensor (MAFS). Disconnect the MAFS electrical connector.

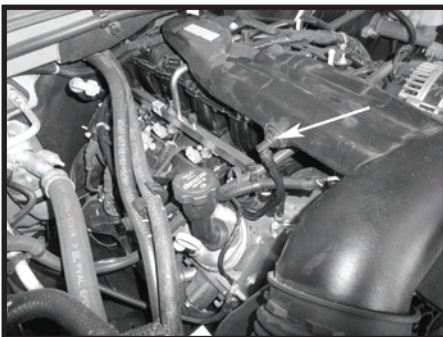

Step 5

Pull firmly and disconnect the breather hose from the stock intake resonator. Remove the factory intake tube.

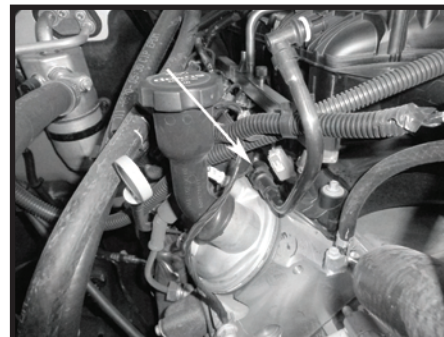

Step 6

Remove the breather tube from the engine. There is a small tab on the end of the tube. Push it to the right to release the breather tube.

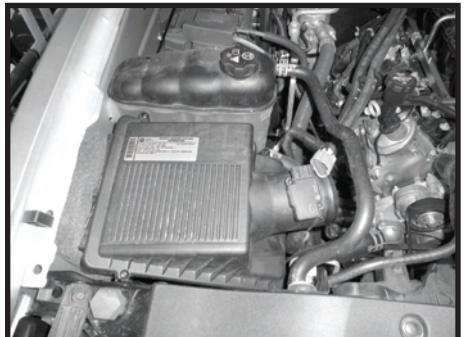

Step 7

Remove the air box assembly by pulling up and out firmly.

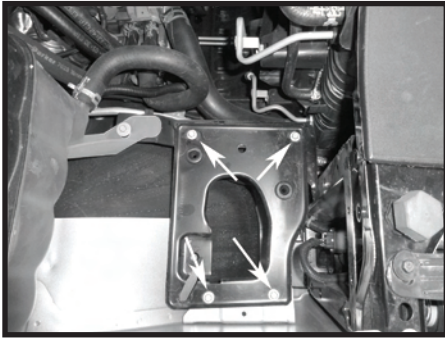

Step 8
Remove the air box mounting plate. Two of these bolts will be re installed with the new heat shield.

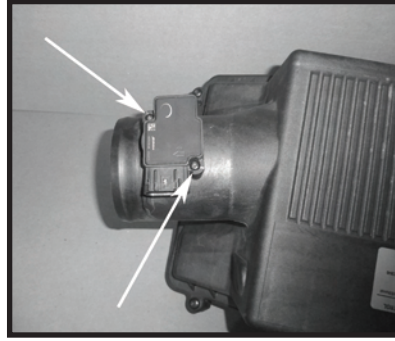

Step 9
Remove the MAFS from the factory air box.

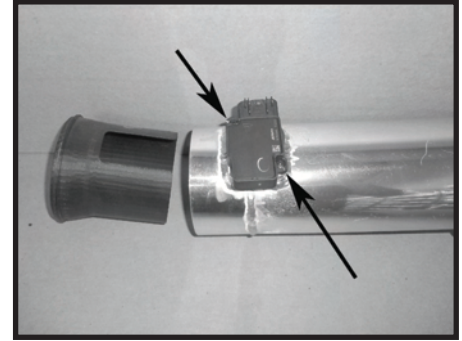

Step 10
Insert and fasten the MAFS onto the Spectre Performance intake tube with the provided machine screws. Insert the MAFS sleeve into the intake tube (note position of slot to allow clearance for the MAFS).



Step 11
Assemble the heat shield with the tabs placed on the outside of heat shield. Install the rubber bulb seal. Place the velocity stack adapter in the heat shield and install the supplied flex coupler making sure the coupler is pushed completely against the heat shield. Take note of the orientation of the funnel, this may be rotated slightly once the filter is installed in the vehicle. Once the adapter and coupler are tight against the heat shield, tighten the clamp.

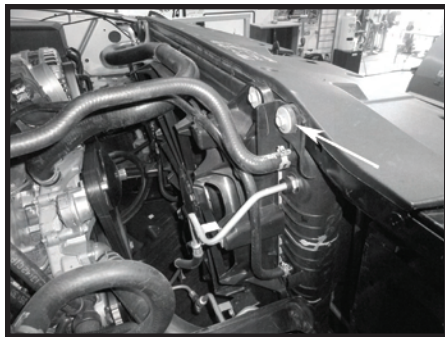

Step 12
Remove the bolt from the radiator shroud. This will be reused in Step 14.

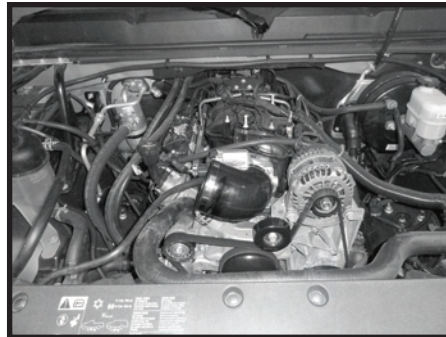

Step 13
Install the 90° boot on throttle body with the short side on the throttle body and clamp on the throttle body side to secure the boot in place. Install a second clamp but do not tighten at this time.

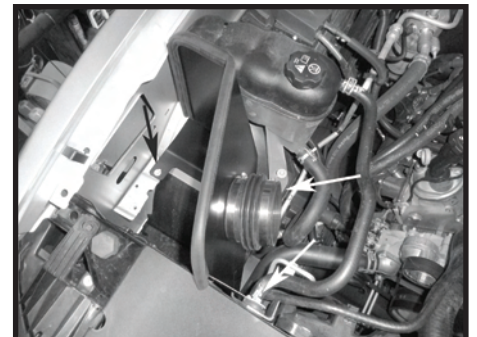

Step 14
Install the heat shield into the truck as shown by reusing the hardware from the tray. There are two bolts that will go in the bottom. The third bolt will be reused from the radiator mount removed in Step 12.

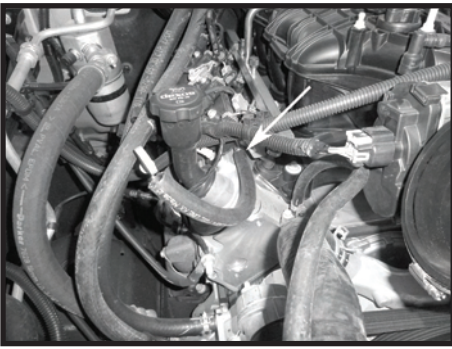

Step 15
Connect the supplied hose to the breather tube on the motor.



Step 16
Install the intake tube as shown and once in position tighten clamps.

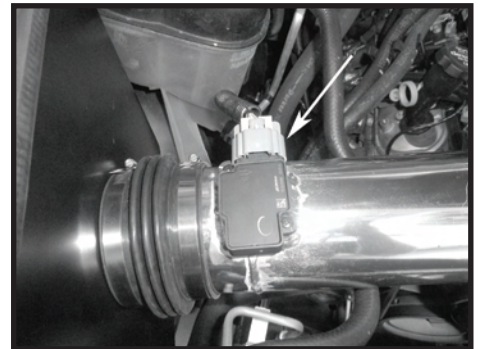

Step 17
Reconnect the MAFS wiring harness.

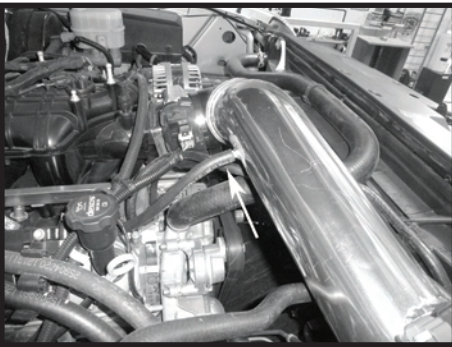

Step 18
Install the new hose onto the vacuum fitting on the intake tube.

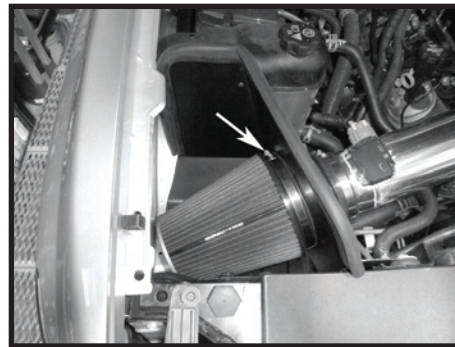

Step 19
Install the filter and fully tighten the clamp.

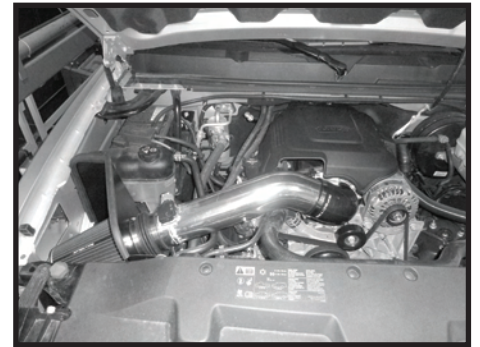

Step 20
Reinstall the engine cover. Make sure that all clamps and hardware are fully tightened. Reconnect the battery cable, start the vehicle and let it warm up. Shut off and inspect the installation once more for any loose clamps, wires, or hardware. Test drive & enjoy! Your installation is now complete. Periodically check all clamps and brackets.

If you have any difficulties or questions regarding the installation of this intake system, contact the Spectre Performance Technical Department by email - Tech@spectreperformance.com or by phone (909) 673-9800 Monday thru Thursday 6:00am to 4:30pm PST.

SPEED BY SPECTRE

The 400mph Company

(909) 673-9800

www.SpeedBySpectre.com